



For more information, please visit: <https://theopump.com/>
Customer service: service@theopump.com

SMART BREATHING TRAINER

Model: LM-B001



POWERED BY
Light&Move
TECH

THANK YOU FOR CHOOSING **OPUMP**

Register on the Website to Get



Warranty
Extra 1 Year Warranty



Priority
Customer Service



VIP
Exclusive Discounts

Package List



Breathing
Trainer



Cotton Swab
x2



Extension
Tube



Mouthpiece
x2



Manual

Table of content

- 01 Important Safety Guidelines
- 02 Specifications
- 03 Getting to Know Your Smart Breathing Trainer
- 04 Indicator Light Instructions
- 05 Using Your Breathing Trainer
- 08 Care & Maintenance
- 09 Warranty

Important Safety Guidelines

Read all instructions before using the Breathing Trainer.
When using electrical appliance, basic safety precautions should always be followed, including the following:



- Read all instructions carefully before using this product. Retain this user manual for future reference.
- The appearance is different from the actual product, please refer to the actual product.

Warning:

1. Keep the device and accessories dry. Do not use heating products such as microwave oven or hair dryer to dry the device and accessories.
2. DO NOT let the device drop, hit or be be stricken heavily.
3. Turn off the device before clean.
4. DO NOT wash or clean the device with strong chemical reagents or strong detergents. Clean the dust with a cotton swab or a soft cloth.
5. DO NOT tamper, disassemble, or attempt to repair the device. If there is a need to alter or repair, please contact our customer service team.
6. DO NOT use the device in the place that no wireless device is allowed.
7. Oral pressure occurs while using the breathing trainer, which may affect implanted and personal medical devices, such as pacemaker, cochlear implants, hearing-aid. Please consult your doctor before using if implanted any medical device.
8. DO NOT use the device in dust, damp, dirty or magnetic places to avoid circuit failure.
9. Use the device at the temperature between 5°C to 45°C. Too low or too high temperature may cause device failure.
10. DO NOT place the device and accessories near heat or fire, such as electric heater, microwave oven, etc.
11. Keep the device and accessories out of reach of children.
12. DO NOT keep the device in damp place to avoid device failure.

Specifications

Product Name:	Smart Breathing Trainer
Model:	LM-B001
Measuring Range:	0ml-4500ml
Battery Capacity:	400mAh
Battery Type:	Lithium battery
Battery Life:	15 hrs
Charging Input:	5V 1A
Charging Time:	2hrs
Dimensions:	35x35x136mm
Weight:	100g
Material:	ABS Plastic
Connection:	Bluetooth 4.0
Display:	LED Lights

Getting to Know Your Smart Breathing Trainer

Smart Breathing Trainer For Maintaining and Improving Inspiratory Volume and Respiratory Fitness

Product Diagram

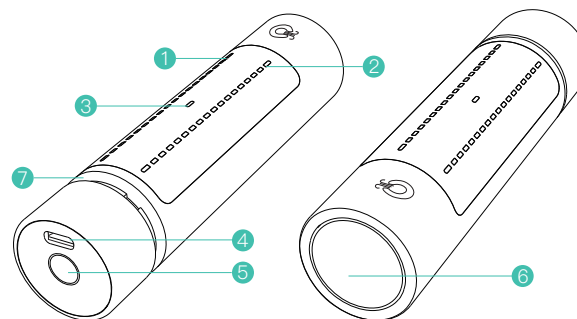

- 1 Flow Rate LED
- 2 Flow Volume LED
- 3 Power/Bluetooth LED
- 4 Charging Port
- 5 Power Switch
- 6 Air Hole
- 7 Air Inlet

Indicator Light Instructions

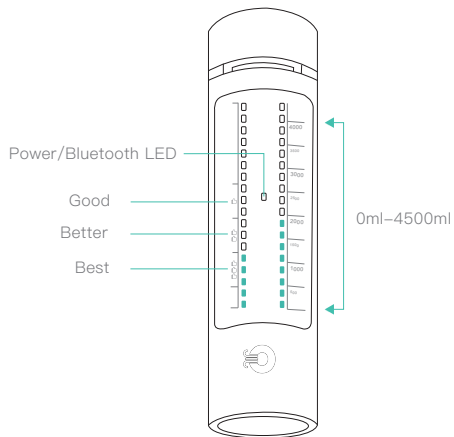

Power LED	Status	Light Effect
Work	Power on	Always on
	Bluetooth connected	Short flash, and then on
	Low battery	Intermittent flash
Charging	Charging	Slow flash
	Fully charged	Always on

Using Your Breathing Trainer

1. Off-line Operation



1) Press the power switch for 2s, and the power LED on.



2) Attach the mouthpiece to the air hole of the trainer, or attach the mouthpiece to the extension tube, and attach the tube to the trainer according to your own need.

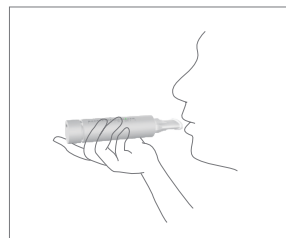

3) Hold the trainer. Exhale normally. Then place lips tightly around mouthpiece.

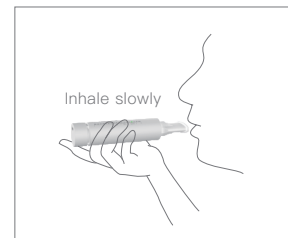

4) Inhale slowly to raise Flow Volume LED. For:
 (a) Vital Capacity test: slowly inhale, and try to raise Flow Volume LED as high as possible. When inhalation is complete, remove mouthpiece, and exhale normally.

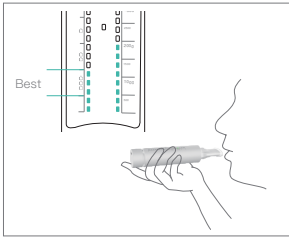

(b) Breathing Trainer: slowly inhale, and maintain the Flow Rate LED in the “Best” (☆☆☆) flow range. Try to raise Flow Volume LED to specified volume level. When inhalation is complete, remove mouthpiece, hold the breath as specified, and exhale normally. Reset and repeat trainer. (Frequency of use and recommended inspiratory volumes should be set according to your own situation at the direction of training courses, your coach, physician or therapist.)



5) To shut down the trainer, press the power switch for 2s and the power LED off.



⚠ Note: DO NOT block air inlet of the breathing trainer during use.



2. Online Operation (Connect to the App)

1) App Installation

Search “OPUMP” in the Android Application Market, the iOS App Store, the HUAWAI Application Market to download and install the App.

App downloaded via other channels may be unusable. Before pairing with your equipment, make sure your equipment meets the following requirements:

- iPhone 5S and above with iOS 10.0 and above system;
- Android 5.0 and above with Bluetooth 4.0



Scan QR Code
Download <OPUMP App>

2) Connect to the Breathing Trainer via Bluetooth

Open OPUMP App and Bluetooth of the phone, follow the instruction of the App to register/log in and connect to the trainer.

3) OPUMP App

OPUMP App provides different courses and vital capacity test. You can set goals, take the courses and record the training.

Care & Maintenance

The unit should be cleaned after every use.

- Clean the trainer with the cotton swab;
- Rinse mouthpiece and extension tube and shake dry;

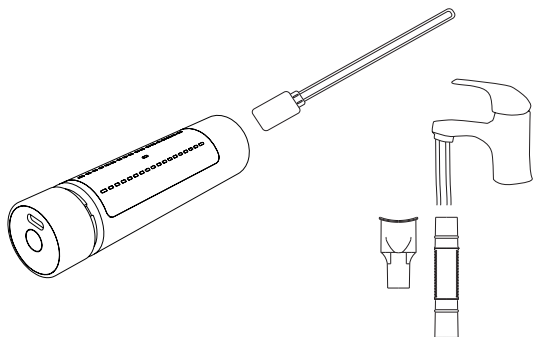

⚠ Never immerse the trainer into water or any other liquid.

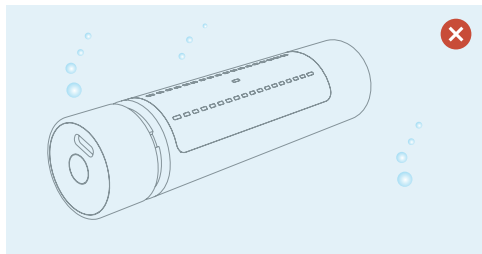

Note:

Mouthpiece and Extension Tube: Single Person Use Only.

Warranty

Thank you for purchasing OPUMP products. This product is guaranteed for one year from the date of purchase.

By registering your product on our website (<https://theopump.com/>), the warranty period can be extended to 24 months.

If you encounter any problems, please contact with us by the following way, and attach your order number and detailed information about the problem. Under normal circumstances, we will contact you within one working day.

Website: <https://theopump.com/>

After sales email: service@theopump.com

Please read the User Guide carefully and use it strictly according to the user guide.

This warranty does not cover product damage caused by normal wear, scratches, improper use, failure to follow the instructions in the User Manual or use for commercial purposes.

For products purchased from retailers and distributors, please contact the corresponding retailers and distributors to provide you with the corresponding after-sales service.

Predictive Nomogram Inspiratory Capacity* (ml)**

FEMALE

HEIGHT

		58''	60''	62''	64''	66''	68''	70''	72''	74''
		1.45m	1.52m	1.57m	1.63m	1.68m	1.72m	1.78m	1.83m	1.88m
AGE IN YEARS	20	1900	2100	2300	2500	2700	2900	3100	3300	3500
	25	1850	2050	2250	2450	2650	2850	3050	3250	3450
	30	1800	2000	2200	2400	2600	2800	3000	3200	3400
	35	1750	1950	2150	2350	2550	2750	2950	3150	3350
	40	1700	1900	2100	2300	2500	2700	2900	3100	3300
	45	1650	1850	2050	2250	2450	2650	2850	3050	3250
	50	1600	1800	2000	2200	2400	2600	2800	3000	3200
	55	1550	1750	1950	2150	2350	2550	2750	2950	3150
	60	1500	1700	1900	2100	2300	2500	2700	2900	3100
	65	1450	1650	1850	2050	2250	2450	2650	2850	3050
	70	1400	1600	1800	2000	2200	2400	2600	2800	3000
75	1350	1550	1750	1950	2150	2350	2550	2750	2950	
80	1300	1500	1700	1900	2100	2300	2500	2700	2900	

MALE

HEIGHT

		58''	60''	62''	64''	66''	68''	70''	72''	74''	76''	78''
		1.45m	1.52m	1.57m	1.63m	1.68m	1.72m	1.78m	1.83m	1.88m	1.93m	1.98m
AGE IN YEARS	20	2000	2200	2400	2600	2800	3000	3200	3400	3600	3800	4000
	25	1950	2150	2350	2550	2750	2950	3150	3350	3550	3750	3950
	30	1900	2100	2300	2500	2700	2900	3100	3300	3500	3700	3900
	35	1800	2000	2200	2400	2600	2800	3000	3200	3400	3600	3800
	40	1750	1950	2150	2350	2550	2750	2950	3150	3350	3550	3750
	45	1700	1900	2100	2300	2500	2700	2900	3100	3300	3500	3700
	50	1650	1850	2050	2250	2450	2650	2850	3050	3250	3450	3650
	55	1550	1750	1950	2150	2350	2550	2750	2950	3150	3350	3550
	60	1500	1700	1900	2100	2300	2500	2700	2900	3100	3300	3500
	65	1400	1600	1800	2000	2200	2400	2600	2800	3000	3200	3400
	70	1350	1550	1750	1950	2150	2350	2550	2750	2950	3150	3350
75	1300	1500	1700	1900	2100	2300	2500	2700	2900	3100	3300	
80	1250	1450	1650	1850	2050	2250	2450	2650	2850	3050	3250	